

# KATALYST

KATALYST TRAINING SYSTEM  
INSTRUCTION MANUAL | ENGLISH

KPNL6061 VER 3

## **TABLE OF CONTENTS**

<b>YOUR KATALYST JOURNEY</b>	<b>6</b>
<hr/>	
<b>INDICATIONS TO USE</b>	<b>6</b>
<hr/>	
<b>WARNING AND SAFETY GUIDELINES</b>	<b>7</b>
<hr/>	
Safety Guide	7
<hr/>	
Contraindications	8
<hr/>	
Precautions	8
<hr/>	
Warnings and Safety Measures	9
<hr/>	
Adverse Reactions	11
<hr/>	
<b>KATALYST TRAINING SYSTEM COMPONENTS</b>	<b>13</b>
<hr/>	
The Suit	13
<hr/>	
Vest	14
<hr/>	
Shorts	15
<hr/>	
Arm Straps	16
<hr/>	
Arm Connectors	16
<hr/>	
Impulse Pack	17

Turning On Your Impulse Pack	18
Turning Off Your Impulse Pack	18
Impulse Pack LED Status Indicator	18
Base Layer	20
Spray Bottle	21
<b>DIRECTIONS FOR USE</b>	<b>22</b>
Installing and Launching the Katalyst App	22
Preparing Your Suit	23
Putting On Your Suit	25
Selecting Your Workout	30
Pairing Your Impulse Pack	32
Connecting Your Impulse Pack	33
Storing Your Impulse Pack	33
Managing Your Training Session	34
Understanding the Training Interface	34
Pausing and Controlling Your Workout	36

Cast Your Workout To Your TV	37
<hr/>	
<b>TRAINING MODES</b>	<b>37</b>
<hr/>	
<b>CHARGING YOUR IMPULSE PACK</b>	<b>38</b>
<hr/>	
Connecting the Charger	38
<hr/>	
<b>TROUBLESHOOTING</b>	<b>39</b>
<hr/>	
<b>STORAGE AND MAINTENANCE</b>	<b>40</b>
<hr/>	
<b>WARRANTY</b>	<b>41</b>
<hr/>	
<b>TECHNICAL SPECIFICATIONS</b>	<b>41</b>
<hr/>	
Electrode Specifications	42
<hr/>	
Battery	45
<hr/>	
Charging Input	45
<hr/>	
Stimulation Channels	45
<hr/>	
Stimulation Waveform	45
<hr/>	
Supported Stimulation Frequency Range	45
<hr/>	
Supported Stimulation Pulse Widths	46

Maximum Output Voltage	47
<hr/>	
Maximum Output Current	47
<hr/>	
Wireless Connection	47
<hr/>	
Electromagnetic Compatibility	47
<hr/>	
Frequency Band	47
<hr/>	
Max. Radio Frequency Power	47
<hr/>	
Housing materials	47
<hr/>	
Environment Specifications	47
<hr/>	
Limitations	48
<hr/>	
Emissions	48
<hr/>	
Immunity	48
<hr/>	
FCC Requirements	49
<hr/>	
<b>SYMBOLS GLOSSARY</b>	<b>50</b>
<hr/>	
<b>ELECTROMAGNETIC COMPATIBILITY (EMC)</b>	<b>57</b>
<hr/>	
<b>PRODUCT SUPPORT</b>	<b>57</b>
<hr/>	
<b>EU DECLARATION OF CONFORMITY</b>	<b>58</b>



**CAUTION:** Katalyst strongly recommends that all users of the Katalyst Training System carefully read these instructions, contraindications, and safety measures before using the Katalyst Training System.

See the symbols glossary for an explanation of symbols.

## **YOUR KATALYST JOURNEY**

Welcome to Katalyst, an exciting and brand-new way of thinking about your fitness training. Katalyst uses electrical muscle stimulation (EMS) technology to improve body composition, increase strength and endurance, enhance muscle tone, and even address some muscular imbalances.

To engage all your major muscle groups effectively and get the most out of your Katalyst Training System, please read this manual carefully before you start your first workout. For your convenience, the Katalyst Training System is wirelessly controlled by the Katalyst App, which can run on any iPhone or iPad running iOS 16 or higher.

## **INDICATIONS FOR USE**

The Katalyst Training System is an over-the-counter device designed to stimulate healthy muscles in order to improve or facilitate muscle performance. It is to be used by adults only.

The Katalyst Training System is not intended to be used in conjunction with therapy or treatment of medical diseases or medical conditions of any kind. None of the training programs or operational parameters are designed to target injured or ailing muscles; the Katalyst Training System's use on such muscles is contraindicated.

The Katalyst Training System's electrical impulses allow the triggering of action potentials on motoneurons of motor nerves (excitations). These excitations of motoneurons are transmitted to the muscle fibers via the motor endplate, where they generate mechanical muscle fiber responses that correspond to muscle work. Depending on the parameters of the electrical impulses (pulse frequency, duration of contraction, duration of rest, and total session duration), different types of muscle work can be imposed on the stimulated muscles.

## **WARNING AND SAFETY GUIDELINES**

Katalyst recommends that you consult your physician before beginning this or any other fitness program.

Text throughout this instruction manual that is marked with a  symbol indicates a situation, which, if not avoided, may result in minor or moderate injuries to the user or damage to the equipment.

### **Safety Guide**

Please review the following list of questions. If you answer “Yes”, “Maybe”, or “I don’t know” to one or more of the following, you should NOT USE the device.

1. Do you have a pacemaker, implanted defibrillator, or other implanted metallic or electronic device?
2. Are you pregnant?
3. Are you experiencing extreme muscle strain or trauma or a muscle strain condition such as Rhabdomyolysis?
4. Have you been diagnosed with any heart problem or condition?
5. Do you have an inadequate blood supply (ischemia) or serious blood circulation disorders in the lower limbs?
6. Have you been diagnosed with an abdominal or groin hernia?
7. Have you recently undergone surgery?
8. Have you recently experienced acute trauma or fractures?
9. Have you been diagnosed with epilepsy or another neurological disorder?
10. Have you experienced nerve damage resulting in a lack of feeling in a particular body area?
11. Do you have persistent pain?
12. Do you require muscle rehabilitation?
13. Do you have a suspicion of any heat condition?
14. Do you have cancer?
15. Do you have painful or afflicted joints?
16. Do you have muscle spasms?
17. Have you experienced a loss of muscle tissue or muscle atrophy?
18. Do you have a tendency to bleed internally (hemorrhage) following trauma or fractures?
19. Are you in the presence of electrical monitoring equipment (e.g., cardiac monitors, ECG devices)?
20. Are you under the age of 18?

## **Contraindications**

The following are contraindications that indicate a situation in which the Katalyst Training System must not be used:

- Do not use the Katalyst Training System if you have a pacemaker (artificial pacemaker), implanted defibrillator, or other implanted metallic or electronic device. Such use could cause electric shock, burns, electrical interference, or death.
- Do not use the Katalyst Training System over a menstruating or pregnant uterus. The safety of using powered muscle stimulators during pregnancy has not been established.
- Do not use the Katalyst Training System if you are experiencing extreme muscle strain or trauma or if you are experiencing a muscle strain condition such as rhabdomyolysis.
- Do not use the Katalyst Training System if you have been diagnosed with any heart problem or condition.
- Do not use the Katalyst Training System if you have an inadequate blood supply (ischemia) or a serious blood circulation disorder in the lower limbs.
- Do not use the Katalyst Training System over an abdominal or groin hernia.

## **Precautions**

The following are precautions that Katalyst recommends that you review before using the Katalyst Training System:

- Caution should be used when there is a tendency to bleed internally (hemorrhage) following trauma or fracture.
- Caution should be used following acute trauma or a fracture or following recent surgery when muscle contraction may disrupt the healing process.
- Consult your physician before using the Katalyst Training System if you have been diagnosed with epilepsy or another neurological disorder.
- Caution should be used when there is nerve damage resulting in a lack of feeling in a particular area of the body.



- Consult your physician before use if you have experienced a loss of muscle tissue or muscle atrophy, experience muscle spasms, or have muscles associated with painful or afflicted joints.
- Consult your physician before use if you have persistent pain.
- Consult your physician before use if you require muscle rehabilitation.
- Consult your physician before use if there is suspicion of any heart condition. The device may cause lethal rhythm disturbances to the heart in susceptible individuals.

### **Warnings and Safety Measures**

The following are general warnings and safety measures that you should review before using the Katalyst Training System:

- Only use the Katalyst Training System with the provided base layer.
- The Katalyst Training System is only for use by adults.
- Do not use the suit on parts of the body it was not designed for such as using the arm straps on the calves.
- Do not touch the inside of the suit or the snaps with your hands during training. If a suit adjustment is needed, stop the training first and then make the adjustment.
- No modification of the Katalyst Training System equipment is allowed.
- Do not charge the impulse pack while it is attached to the suit.
- Stimulation should not be applied near metal. Remove all jewelry, body piercings, belt buckles, or any other removable metallic product or device in areas of stimulation.
- Stimulation should not be applied over the neck (specifically the carotid sinus nerves), particularly in patients with a known sensitivity to the carotid sinus reflex.
- Stimulation should not be applied over the neck or mouth. Severe spasms of the neck or airway muscles may occur, and the contractions may be strong enough to close the airway or cause difficulty in breathing.
- Although the design of the Katalyst Training System prevents electrical current from crossing the chest cavity (transthoracically), please be advised that stimulation should not be applied across the chest cavity in order to prevent

electrical current from reaching the heart, where it could cause an irregular heartbeat (cardiac arrhythmias).

- Stimulation should not be applied to the head or any sites that may cause electrical stimulation to pass through the head (transcerebrally). The effects of stimulation of the brain have not been established yet.
- Stimulation should not be applied over swollen, infected, or inflamed areas (e.g., phlebitis, thrombophlebitis, varicose veins).
- The long-term effects of chronic electrical stimulation have not yet been established.
- Stimulation should not be applied over or in proximity to cancerous lesions.
- Do not apply stimulation to muscle groups if you have any concerns related to your comfort or safety.
- Do not use the Katalyst Training System if connected to any electronic monitoring equipment (e.g., cardiac monitors, ECG devices). These devices may not operate properly when electrical stimulation is in use.
- Do not use the Katalyst Training System in water or a humid atmosphere (sauna, hydrotherapy, etc.).
- Do not use the Katalyst Training System in an oxygen-rich area, such as in the presence of oxygen tanks.
- Do not use the Katalyst Training System while driving, operating machinery, cycling or during any activity in which electrical stimulation can put you at risk of injury to yourself or others.
- Do not apply stimulation while sleeping.
- Keep the Katalyst Training System device and its accessories out of reach of children and pets.
- Do not use the Katalyst Training System on animals.
- Do not allow any foreign objects (soil, water, metal, etc.) to enter the impulse pack.
- Do not tamper with the suit or impulse pack (e.g., by trying to open them).
- Sudden temperature changes can cause condensation to build up inside the impulse pack. Only use once temperatures have returned to normal.
- Do not overexert yourself during electrical muscle stimulation training. Any training should be at a level comfortable for you.

- Do not use the Katalyst Training System if you are connected to a high-frequency surgical instrument, as this could cause skin irritations or burns under the pads.
- Do not use the Katalyst Training System near shortwave or microwave therapy medical equipment. This may lead to instability in the impulse pack.
- The Katalyst Training System must not be used near medical devices such as MRI, CT, diathermy, and X-Ray as those could alter the current generated by the impulse pack, cause tissue damage, and result in severe injury or death.
- The Katalyst Training System must not be used in areas where unprotected devices are used to emit electromagnetic radiation. Portable communications equipment, RFID, and electromagnetic security systems (e.g., metal detectors and EAS) can interfere with the Katalyst Training System and alter the current generated by it.



**CAUTION:** Not all RF emitters are visible. If you experience any unexpected changes in intensity, please immediately end your training and consult Katalyst.

### **Adverse Reactions**

- Some people with very sensitive skin may experience redness or irritation under the pads after electrical muscle stimulation. Generally, this redness is completely harmless and should disappear shortly. Avoid starting training until the redness is no longer visible. If redness persists, stop using the Katalyst Training System and consult your physician.
- Some people may experience headaches and other painful sensations during or following the training. If this occurs, a physician should be consulted, and training should cease until gaining approval from a physician.



**CAUTION:** If you experience adverse reactions, stop using the Katalyst Training System immediately and consult your physician.

## KATALYST TRAINING SYSTEM COMPONENTS

The Katalyst Training System consists of three main components: the suit, the impulse pack, and the base layer. All three of these components, as well as the included spray bottle, are described in this section.

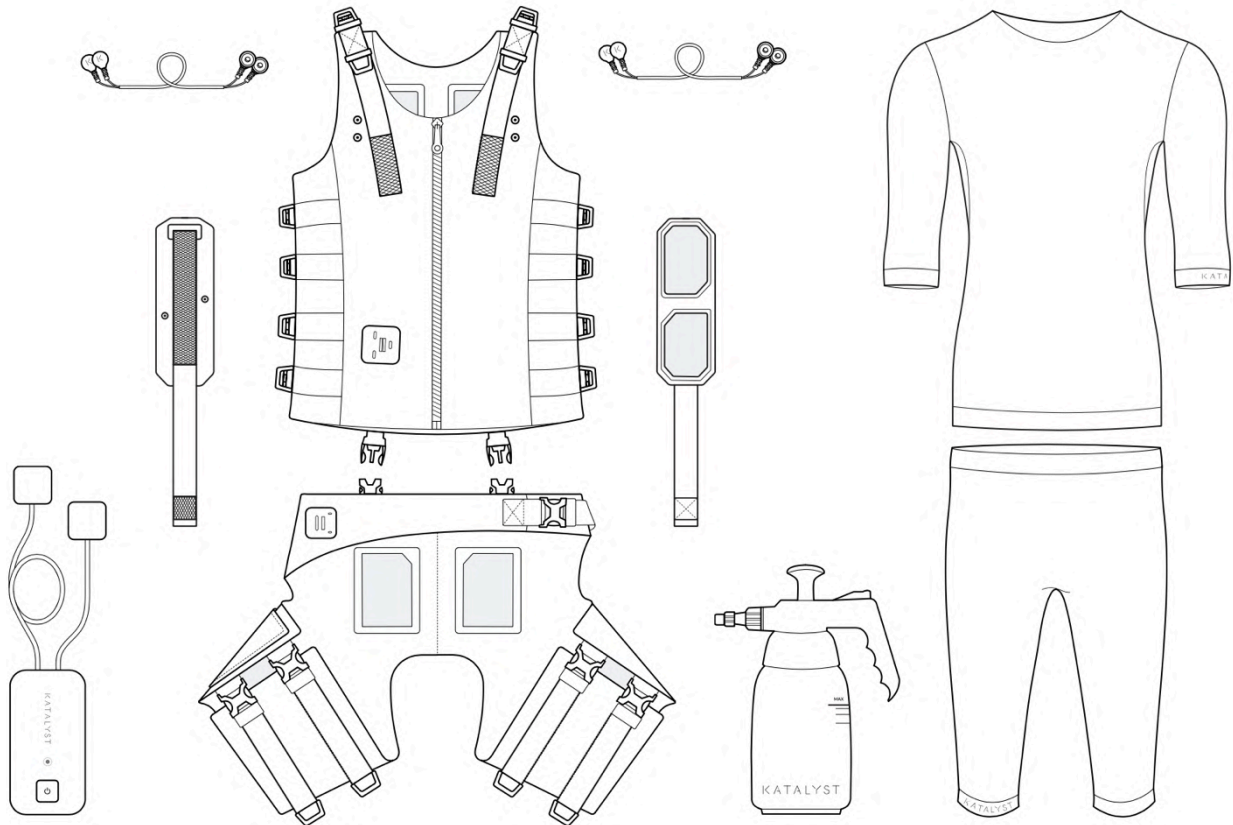

### The Suit

The suit delivers impulses directly from the connected impulse pack to all of your major muscle groups. The suit consists of four separate components: vest, shorts, arm straps, and arm connectors.



**CAUTION:** It is advised not to share suits with others as this can lead to improper fitting of the suit or sharing of bodily fluids.

## Vest

The vest is worn during all training sessions and features pads at predefined locations for upper-body muscle stimulation.

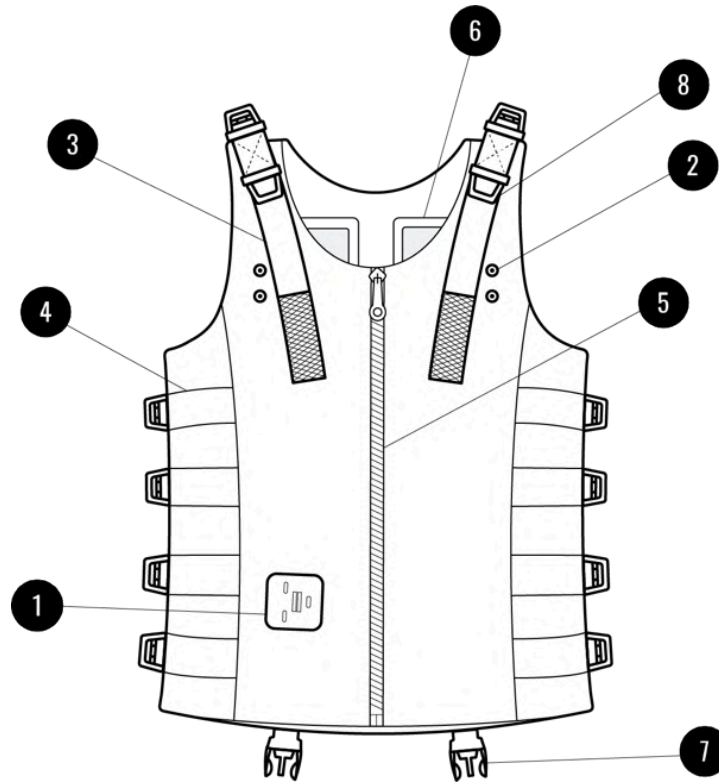

- 1 Connector port
- 2 Snaps for arm connector
- 3 Shoulder straps with Velcro®
- 4 Side straps
- 5 Zipper
- 6 Pads
- 7 Buckles
- 8 D-Rings

## Shorts

The shorts feature pads at predefined locations for lower-body muscle stimulation.

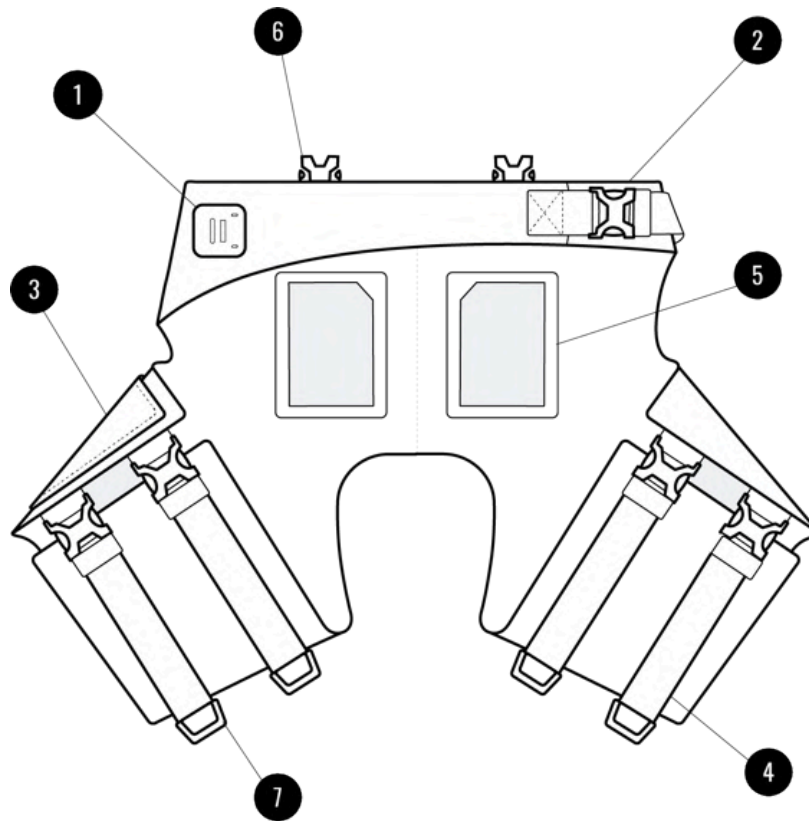

- 1 Connector port
- 2 Hip belt with Velcro®
- 3 Impulse pack pocket
- 4 Leg straps with buckles
- 5 Pads
- 6 Buckles
- 7 D-Rings

## Arm Straps

The arm straps are worn around the middle of your upper arms during all training sessions and feature pads at predefined locations for stimulation of the upper arm muscles.

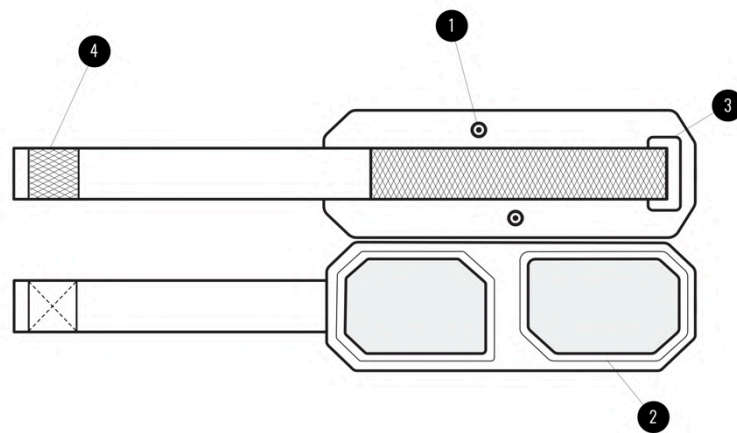

- 1 Snaps for arm connectors
- 2 Pads
- 3 Loops
- 4 Velcro®

## Arm Connectors

The arm connectors are used to connect the arm straps with the vest.

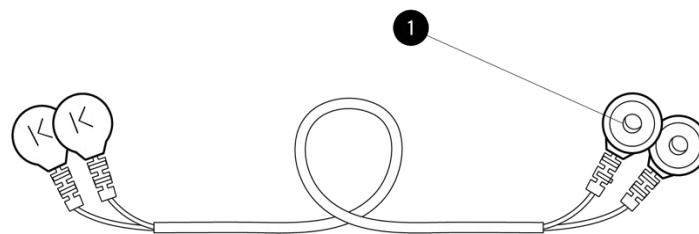

- 1 Snaps

## Impulse Pack

The impulse pack is the control center for your Katalyst Training System. This small device employs low-frequency impulses to generate muscle contraction, which multiplies each muscle group's work rate and output. It communicates wirelessly with the Katalyst app.

For your convenience, the impulse pack is designed to fit in the pocket of the suit during your workout.

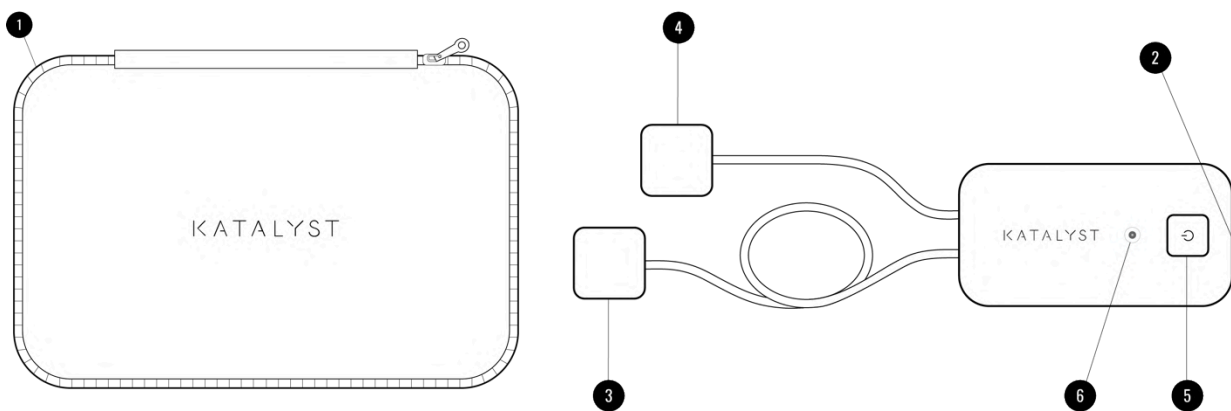

- 1 Carry case
- 2 Micro-USB connector
- 3 Vest connector
- 4 Shorts connector
- 5 Power button
- 6 LED status indicator

You can easily identify the vest connector from the shorts connector, as the vest connector is longer than the shorts connector. Additionally, each connector is designed so that it cannot attach to the incorrect connector port.



## Turning On Your Impulse Pack

The impulse pack has a single button to turn it on and off. When the LED status indicator displays a color, the impulse pack is on. If no color is displayed, the impulse pack is off.

To turn on the impulse pack, press and hold the power button for 3 seconds. The LED status indicator will indicate that the impulse pack is on.

NOTE: If you press and hold the button for 5 seconds when turning on the impulse pack, it will enter pairing mode. For more information, see [Pairing Your Impulse Pack](#).

## Turning Off Your Impulse Pack

When you are finished with your workout, press and hold the power button for 3 seconds to turn the impulse pack off. The impulse pack will turn off the LED status indicator to indicate that it is off.

The impulse pack will automatically turn off after 10 minutes if it is not connected to your iPhone or iPad.

## Impulse Pack LED Status Indicator

The impulse pack communicates with you through the LED status indicator, letting you know its current status. The following table lists the impulse pack states and the LED color and action associated with the state.

State	Indicator Light	Description
Off	None	The impulse pack is powered off and is not charging.
Connecting	Blue flashing slowly	The impulse pack is on and in connection mode. For more information, see <b>Connecting Your Impulse Pack</b> .
Pairing	Blue flashing rapidly	The impulse pack is on and in pairing mode. For more information, see <b>Pairing Your Impulse Pack</b> .
Ready	Solid blue	The impulse pack is on and connected to your iOS device, and it is ready for you to begin your workout.

Training – Not Stimulating	Solid white	The impulse pack is on and in training mode, but it is currently not delivering impulses.
Training – Stimulating	Solid magenta	The impulse pack is on and in training mode, and delivers impulses.
Paused	White flashing slowly	The impulse pack is paused.
Low Battery	Yellow flashing slowly	The impulse pack battery needs to be charged.
Charging	Green flashing slowly	The impulse pack is charging.
Fully Charged	Solid green	The impulse pack is fully charged.
Error	Solid red	The impulse pack is in an error state. Turn the impulse pack off and then on. If this still occurs, please contact support.

## Base Layer

The base layer consists of a shirt and a pair of shorts. They are designed to be worn underneath the suit during training and should have direct contact with your skin.

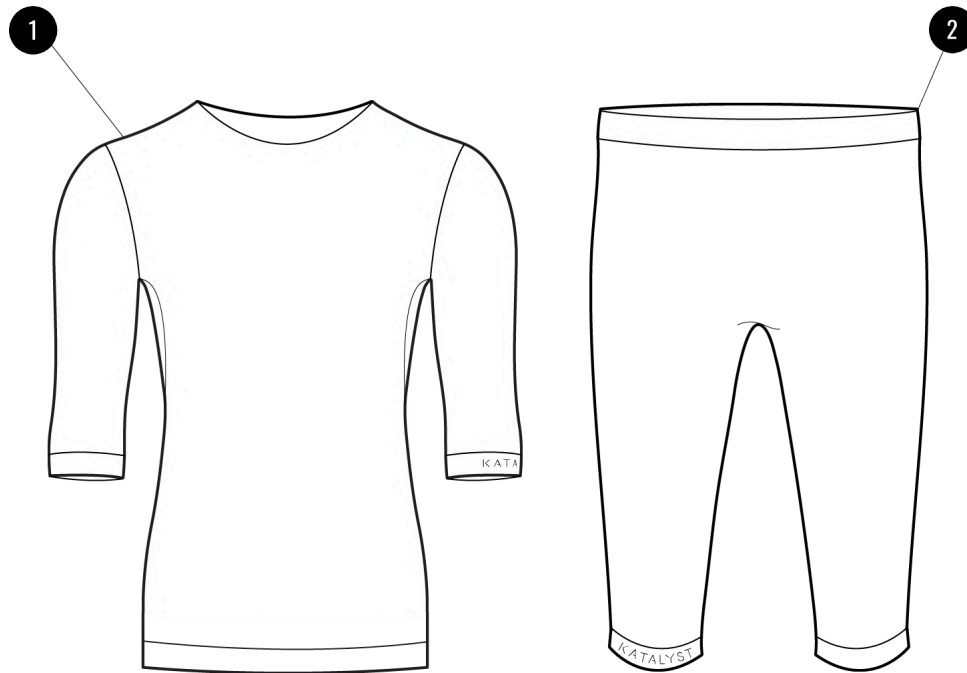

- 1 Shirt
- 2 Shorts



**CAUTION:** For maximum efficacy, do not wear anything underneath the base layer.

## Spray Bottle

The Katalyst Training System includes a spray bottle, which allows you to wet the pads of your suit to get the best connectivity for your workouts.



- 1 Pump
- 2 Trigger
- 3 Adjustable spray nozzle
- 4 Maximum water line

## **DIRECTIONS FOR USE**

Before you begin your workout with the Katalyst Training System, you must first install and configure the Katalyst App on your iPhone or iPad and adjust your suit so that it is tight against your body but still comfortable.

### **Installing and Launching the Katalyst App**

The Katalyst App is an application that controls and manages your Katalyst Training System workouts.



To install the app, please use one of the following two methods:

- Open the Camera app on your iPhone or iPad. Using the Camera app, center the QR Code below (or on the back page of the Quick Start Card) on the screen so it is clearly visible. A banner notification displays, allowing you to open the link associated with the QR code.



- Launch the App Store from your iPhone or iPad. Search for the Katalyst mobile app and install it.



After successfully installing the Katalyst App, open it and follow the on-screen instructions for signing up or logging in.

## Preparing Your Suit

Before beginning this step, ensure you have filled the spray bottle with water (we recommend warm water for your comfort) up to the maximum water line and pumped it approximately 20 times.



**CAUTION:** Always inspect your suit and base layer for rips, tears, or any other type of damage. If damage is present, replace the damaged suit or base layer. Do not use the suit or base layer when damaged.

To prepare the suit for your workout, use the following steps:

1. Put on your base layer.
2. Lay the vest and shorts on the floor.
3. Connect the vest to the shorts using the attached buckles.



4. Open the vest and the shorts to reveal the pads.



5. Place the arm straps on the floor so the pads are facing up.
6. For each pad on the vest, shorts, and arm straps, do the following:
  - a. Place the nozzle directly on the pad, pressing down so that the nozzle is always in contact with the pad's surface. Turn the spray nut all the way to the right to set the spray pattern to mist; this is the optimal setting for wetting the pads.



- b. Squeeze the trigger to start spraying.
- c. Continue squeezing the nozzle across the pad in a zigzag pattern.

- d. Press the pad with your fingers to ensure the correct amount of wetness. You should observe water coming to the pad's surface with little pressure.



**CAUTION:** Pads must be sufficiently soaked with water. This can be tested by placing a finger on the electrode and pressing down. Water should come out of the pad with little pressure.

### Putting On Your Suit

The following provides instructions on putting on the suit.



**CAUTION:** Katalyst recommends that you only wear the provided base layer underneath the suit during your workouts to achieve maximum efficacy.



1. Put on the prepared vest and shorts, and zip up the vest.



2. Wrap the hip belt around your waist and attach using the Velcro®. Then connect the buckle and tighten the Velcro® again, if needed.



3. Wrap a leg strap around each of your thighs and close each buckle.



4. Tighten the leg straps of the shorts, ensuring that the front pad is centered in the middle of your thigh, and attach them using the Velcro®.
5. Pull the D-Rings of the side straps of the vest to tighten, starting from the bottom, to ensure good compression. If needed, lift up the loops to loosen the side straps.



6. Pull down both shoulder straps simultaneously to tighten the vest. When finished, firmly attach the shoulder straps using the Velcro® on the chest section of the vest to secure them.



**CAUTION:** A loose or non-optimal compression of the pads may degrade the muscle stimulation.

7. Wrap the arm straps around the middle of your upper arm, ensuring they are positioned over the base layer and that the pads are tight but comfortable.



**CAUTION:** Over-tightening of the arm straps may lead to pinching the skin.

8. Attach the arm connectors to the vest and the arm straps on each side.



9. Grab your impulse pack and pull the cables through the loop at the back of your shorts.



10. Attach the vest connector to the vest and the shorts connector to the shorts using the built-in magnets, and keep the impulse pack in your hands for the next steps.



## Selecting Your Workout

Open the Katalyst App on your iPhone or iPad and access the Katalyst Workout Library on the Home tab. The library lists all of the available workouts.



**CAUTION:** If this is your first time, Katalyst recommends you start using low-intensity settings before progressing to higher intensities to familiarize yourself with the sensation.

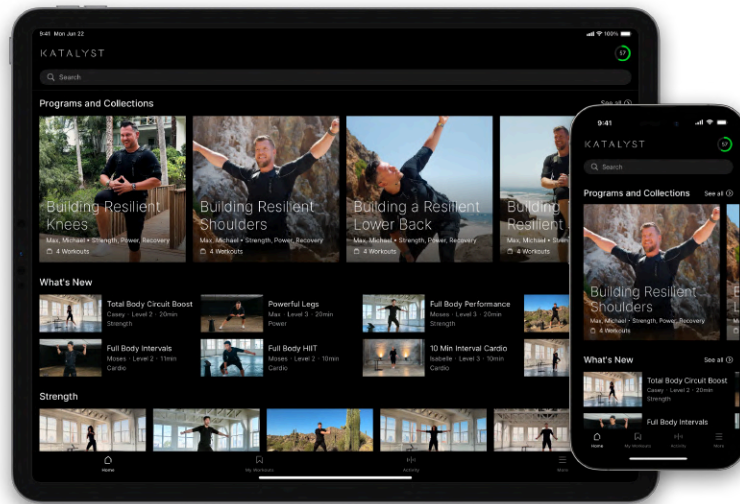

The library page provides the following details for each workout:

Workout Name	The name describes the focus of the workout or recovery mode.
Instructor Name	The name of the Katalyst instructor who guides you through your session.
Training Mode	The training mode associated with the workout. Examples of training modes are Strength, Power, Cardio, and Recovery. For more information, see Training Modes.
Exercise Level	The overall level of difficulty of the individual exercises in the workout: <ul style="list-style-type: none"> <li>● Level 1 (Beginner)</li> <li>● Level 2 (Intermediate)</li> <li>● Level 3 (Advanced)</li> <li>● Level 4 (Pro)</li> <li>● Level 5 (Superhero)</li> </ul>

Once you select the desired workout, a description of the workout, including a list of the exercises to be performed during the session, is displayed.

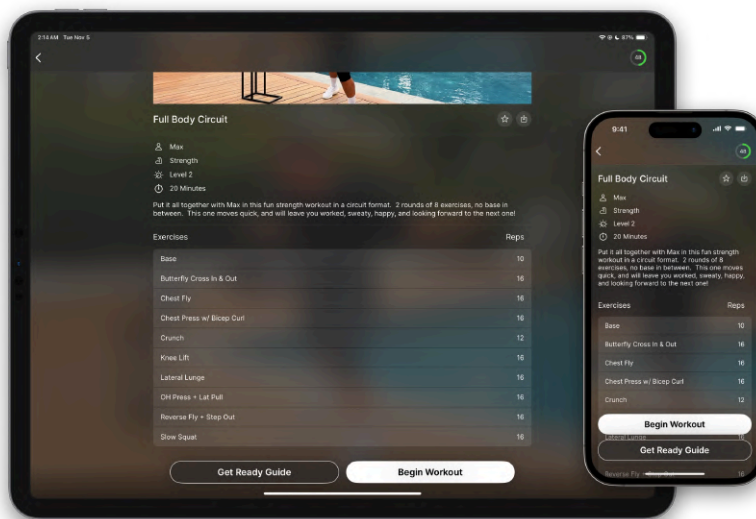

The workout description page provides the following details:

Description	A brief description of the workout goals.
Exercises	A list of exercises that come with the workout.

When you find the workout that fits your training needs, press the Begin Workout button on the screen.

### Pairing Your Impulse Pack

The impulse pack uses Bluetooth to communicate with the application. Before using the impulse pack in your workout, pair it with your iPhone or iPad. To do this, ensure that your device is close to the impulse pack and has Bluetooth turned on. Press and hold the power button for 5 seconds until the blue light flashes rapidly. This indicates that the pairing mode is active.

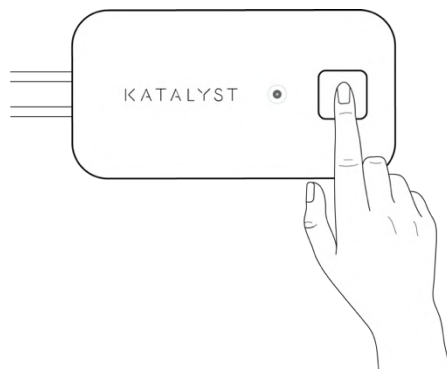



**CAUTION:** Always thoroughly inspect the impulse pack. Do not use the impulse pack if any damage is present. For your safety, please consult Katalyst.

Your iPhone or iPad will confirm that “Katalyst” is trying to use your Bluetooth to connect the impulse pack to your suit. Press OK, and the application will detect your impulse pack.

Congratulations! Your device is now paired with the impulse pack. From now on, whenever you start a workout and turn on the impulse pack, it will automatically pair with it if the iPhone or iPad is in range.

### **Connecting Your Impulse Pack**

Before you can begin your workout, you need to turn on the impulse pack and ensure that it is paired with your iPhone or iPad. Press and hold the power button on the impulse pack for 3 seconds. The LED status indicator slowly blinks blue as it pairs with your preferred device.

Visit [support.katalyst.com/howtopairmyimpulsepack](https://support.katalyst.com/howtopairmyimpulsepack) for video instructions.



**CAUTION:** The Katalyst Training System will not work properly until the impulse pack is paired and connected to your iPhone or iPad.

## Storing Your Impulse Pack

Once you have paired your iPhone or iPad to the impulse pack, you can store your impulse pack.

1. Slide your impulse pack into the pocket of your shorts for the duration of your workout.



The impulse pack is now safely stored, and you are ready to begin your workout.



## Managing Your Training Session

Your workout begins once you have selected the workout, pressed the **Begin Workout** button and paired your impulse pack. Once the workout session begins, the training interface is displayed.

## Understanding the Training Interface

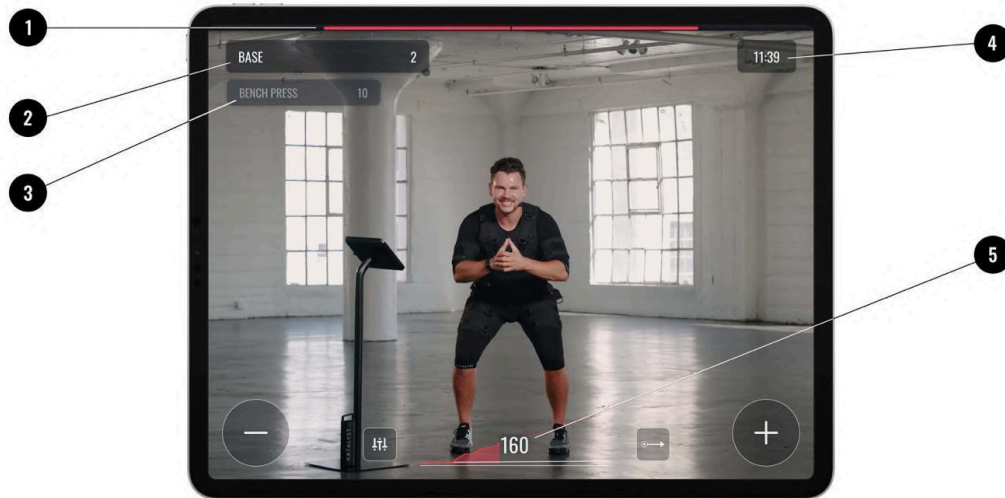

The training interface provides the following information:

Cadence Bar	Displays (1) the remaining time for the current stimulation period: <ul style="list-style-type: none"><li>• When red, the impulse pack sends electrical impulses to the Katalyst Training System components.</li><li>• When white, the impulse pack is in rest and has stopped sending electrical impulses.</li></ul> Please note that the impulse pack provides constant stimulation in cardio mode, so this bar is used to show the duration of the exercise.
Current exercise + Reps	Displays (2) the name and remaining reps for the current exercise. When the number of reps reaches the end, the next exercise is automatically started.

Next exercise + Reps	Displays ( 3 ) the name and number of reps for the next exercise.
Workout Timer	Displays ( 4 ) the remaining time for the total training session.
Overall Intensity Level	Represents ( 5 ) the overall intensity of the training session. Additionally, you can see the intensity graph, showing your current intensity path in relation to the instructor's.
Individual Muscle Group Adjustments	Tap the Channel Drawer button ( [H] ) to adjust which pads receive electrical impulses during your workout session, or adjust groups of pads, such as adjusting whether all shorts or vest pads receive electrical impulses. To disable a pad or group of pads, touch and hold a section or group, until it is no longer selected.
Auto Follow/Stop Follow	Tap the Auto-Follow button ( [A] ) to follow the automatic training increases and decreases. Press the button again to stop following the automatic training increases and decreases, allowing you to choose your training regimen.
Increase/Decrease Overall Intensity	Tap the Plus button ( + ) to increase the overall intensity of the workout. Press the Minus Button ( - ) to decrease the real intensity of the workout.



**CAUTION:** Please note that if you need to disable one or more muscle groups (chest, quads, etc.) from being stimulated, open the channel drawer and touch and hold a section or group until it is no longer selected. Disabled channels are not stimulated for the duration of the workout or until re-enabled.

## Pausing and Controlling Your Workout

To pause your workout session, tap in the middle of the iPhone or iPad screen to display the **Pause** button.



**CAUTION:** If you experience any major discomfort or pain during the workout, immediately pause the training and decrease the intensity as needed.

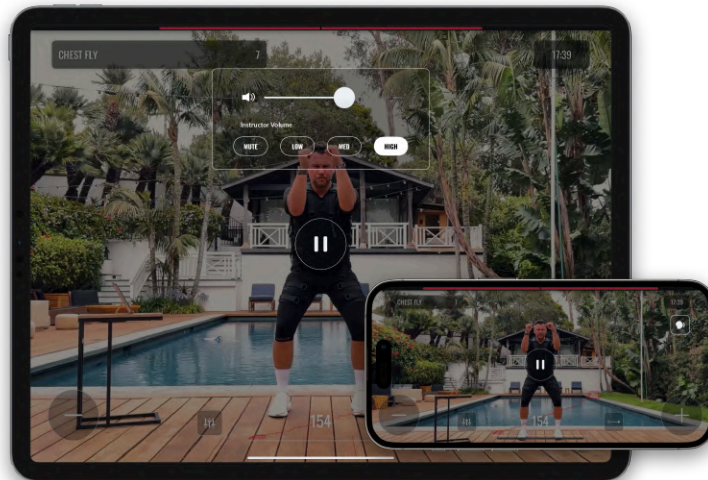

Tapping this button pauses the session and brings up the workout control screen.

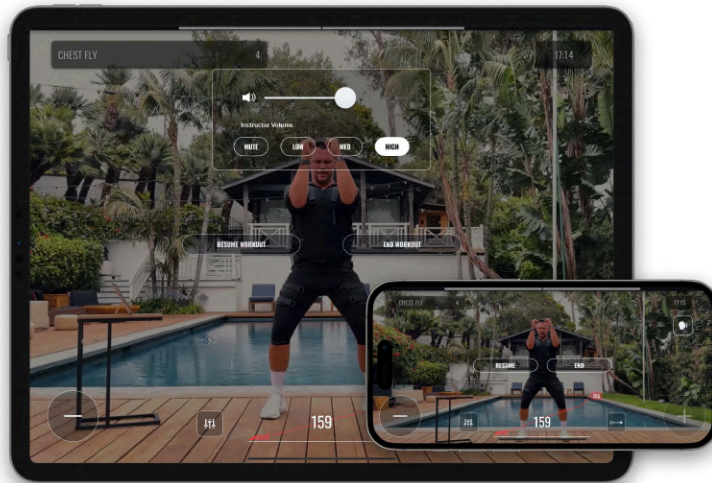

When ready to resume your workout, press the Resume Workout button.

From the workout control screen, you can change the following aspects of your workout:

Instructor Volume	Move the slider bar to the right to increase or to the left to decrease the instructor volume.
-------------------	--

### Cast Your Workout To Your TV

If you have an Apple TV connected to your screen or a Smart TV, you can cast your workout directly to your TV using the Screen Mirroring function of your iPhone or iPad. Please ensure that both devices are connected to the same network.

For more information on how to use AirPlay, please consult [the Apple website](#).

### TRAINING MODES

The workouts in the Katalyst App are assigned to a unique training mode. Each mode is designed to indicate the exercises and work that are focused on during the selected workout. The list below helps you choose a training program appropriate for your workout needs.

Mode	Description
Strength	This program is intended to increase the maximum strength of muscles.
Power	This program increases the speed for maximum muscle strength development.
Cardio	This program improves overall muscle endurance and resistance to fatigue. It activates the aerobic metabolism of the fibers during the training.
Recovery	This program helps to increase blood flow. It should be used after training sessions and competitions.

## CHARGING YOUR IMPULSE PACK

The Katalyst App checks the impulse pack battery level before and after a workout and alerts you if it needs to be charged. Additionally, if the impulse pack battery is low, the LED status indicator displays a slowly flashing yellow light.

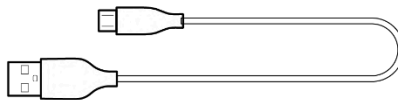

Please note that for optimal charging, Katalyst recommends you use the original charging cable that is provided with your Katalyst Training System.



**CAUTION:** If your impulse pack is connected to a charger and the LED status indicator does not indicate that it is charging, Katalyst recommends unplugging it and contacting Katalyst support.

## Connecting the Charger

To charge your impulse pack, please do the following:

1. Ensure that the impulse pack is turned off by checking the LED status indicator.

2. Disconnect the impulse pack from the suit if it is attached.
3. Connect the charging cable to the micro-USB connector at the bottom of the impulse pack.

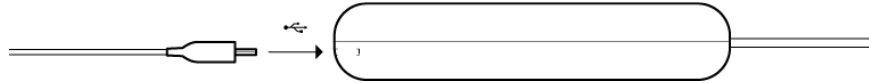

The LED status indicator starts flashing green, indicating that your impulse pack is charging. Once fully charged, the LED status indicator becomes solid green.



**CAUTION:** NEVER charge or recharge the impulse pack when it is attached to your body.

NEVER charge or recharge the impulse pack from unreliable or problematic sources.

## TROUBLESHOOTING

The following is a collection of possible issues with the Katalyst Training System. If you have additional questions or concerns, please contact Katalyst.

Issue	Resolution
The impulse pack doesn't turn on	Connect the charger to the impulse pack. The LED status indicator should turn solid white. Allow the impulse pack to charge for at least 30 minutes. After at least 30 minutes, remove the impulse pack from the charger and turn it on.
The app cannot pair with the impulse pack	Ensure that your impulse pack is powered on. If your iPhone or iPad still cannot find the impulse pack, do the following: <ol style="list-style-type: none"> <li>1. Ensure that the impulse pack is powered off.</li> <li>2. Open Bluetooth from the <b>Settings</b> app on your iPhone or iPad.</li> </ol>

	<ol style="list-style-type: none"> <li>3. From the <b>Bluetooth Devices</b> section, locate <b>Katalyst</b>. If found, tap it and select <b>Forget this device</b>.</li> <li>4. Hold the power button for the impulse pack for 5 seconds until the LED status indicator is rapidly flashing blue.</li> <li>5. Launch the Katalyst App on your device and follow the instructions to pair your impulse pack. Ensure that the impulse pack is close to the iPhone or iPad.</li> </ol>
Suit contact issues	<p>The Katalyst app stops training, disables any channels with a bad connection, and displays the channels that are having issues.</p> <p>Ensure that you are wearing your base layer and that the pads of the suit are adequately soaked with water. Additionally, ensure that the vest connector and shorts connector are properly attached. Then press <b>Resume Workout</b> on your Katalyst App.</p>
Stimulation is weak, even on high intensities	<p>Pause the workout and inspect the suit to ensure all pads are adequately soaked with water. If required, re-wet the pads.</p> <p>If the stimulation is still weak, stop training. Katalyst recommends replacing your suit as it may be worn out.</p>
Stimulation causes discomfort or a burning sensation	<p>Pause the workout and inspect the suit to ensure all pads are adequately soaked with water. If required, re-wet the pads. If the sensation continues, confirm that the suit is adequately tightened to ensure proper compression.</p>

## STORAGE AND MAINTENANCE

Katalyst has the following recommendations for storing and caring for your Training System:

- Keep your suit in a cool, dry, well-ventilated area.
- Keep the impulse pack in the provided carry case when not in use.
- If you plan to store your impulse pack without using it for an extended period of time, you should fully charge it every six months.
- Do not pack the suit or the base layer for an extended period when it is wet (e.g., after training or washing) as mildew and bacteria may build up.

- Wash the base layer after every use with regular detergent. The base layer is designed to be used in household washers.
- The suit is designed to be machine washable on a gentle cycle with cold water (maximum temperature of 30°C (86°F)). To ensure the longevity of your suit, wash it in a laundry bag.
- Katalyst recommends washing your suit every 1-3 months based on frequency of use.
- Always air-dry your suit. Do NOT place your suit in the dryer, as it will damage it.
- You can wipe the suit connectors with a dry rag to ensure no dust or particles are visible on any part of the connector.
- Clean your impulse pack with a soft, dry cloth only.
- The impulse pack is systematically inspected for quality and never requires additional calibration or verification. The workout parameters for the Katalyst Training System are set in the hardware and software and do not degrade over time when used in normal conditions.
- Do not open or alter your Katalyst Training System. This is considered tampering with the unit and releases the manufacturer from any responsibility with regards to the warranty, as well as the hazards that the operator or user may be exposed to.

## **WARRANTY**

For the latest warranty information, please visit [katalyst.com/warranty](https://katalyst.com/warranty).

## **TECHNICAL SPECIFICATIONS**

The following are the technical specifications for the Katalyst Training System.

### **Electrode Specifications**

The electrode pads in your suit are placed according to the position of the specific muscle groups to be stimulated. They are made up of a specialized conductive fabric on top of absorbent foam that allows for the absorption and distribution of water to the base layer. Pad sizes for different suit sizes are as follows:



Specifications for Gen4: KV12-BLK-XXX, KS12-BLK-XXX, KA12-BLK-XXX

Muscle Group Electrode	Surface area by square inch (square cm)					
Vest	11T	12T	13T	14T	15T	16T
Upper Chest	7.20 in <sup>2</sup> (46.47 cm <sup>2</sup> )	8.14 in <sup>2</sup> (52.49 cm <sup>2</sup> )	9.05 in <sup>2</sup> (58.37 cm <sup>2</sup> )	12.70 in <sup>2</sup> (81.93 cm <sup>2</sup> )	16.83 in <sup>2</sup> (108.59 cm <sup>2</sup> )	16.84 in <sup>2</sup> (108.66 cm <sup>2</sup> )
Lower Chest	5.19 in <sup>2</sup> (33.50 cm <sup>2</sup> )	5.99 in <sup>2</sup> (38.64 cm <sup>2</sup> )	7.60 in <sup>2</sup> (48.97 cm <sup>2</sup> )	8.42 in <sup>2</sup> (54.30 cm <sup>2</sup> )	8.73 in <sup>2</sup> (56.35 cm <sup>2</sup> )	10.48 in <sup>2</sup> (67.59 cm <sup>2</sup> )
Top Upper Back	8.65 in <sup>2</sup> (55.80 cm <sup>2</sup> )	9.62 in <sup>2</sup> (62.04 cm <sup>2</sup> )	10.13 in <sup>2</sup> (65.35 cm <sup>2</sup> )	11.06 in <sup>2</sup> (71.34 cm <sup>2</sup> )	11.98 in <sup>2</sup> (77.29 cm <sup>2</sup> )	11.99 in <sup>2</sup> (77.33 cm <sup>2</sup> )
Bottom Upper Back	7.70 in <sup>2</sup> (49.69 cm <sup>2</sup> )	8.97 in <sup>2</sup> (57.89 cm <sup>2</sup> )	11.47 in <sup>2</sup> (73.99 cm <sup>2</sup> )	13.91 in <sup>2</sup> (89.73 cm <sup>2</sup> )	16.35 in <sup>2</sup> (105.49 cm <sup>2</sup> )	16.42 in <sup>2</sup> (105.94 cm <sup>2</sup> )
Middle Back	6.09 in <sup>2</sup> (39.26 cm <sup>2</sup> )	7.41 in <sup>2</sup> (47.78 cm <sup>2</sup> )	8.95 in <sup>2</sup> (57.74 cm <sup>2</sup> )	10.49 in <sup>2</sup> (67.70 cm <sup>2</sup> )	12.66 in <sup>2</sup> (81.66 cm <sup>2</sup> )	12.66 in <sup>2</sup> (81.70 cm <sup>2</sup> )
Lower Back	10.88 in <sup>2</sup> (70.17 cm <sup>2</sup> )	10.89 in <sup>2</sup> (70.22 cm <sup>2</sup> )	18.03 in <sup>2</sup> (116.34 cm <sup>2</sup> )	23.64 in <sup>2</sup> (152.51 cm <sup>2</sup> )	24.41 in <sup>2</sup> (157.46 cm <sup>2</sup> )	24.45 in <sup>2</sup> (157.88 cm <sup>2</sup> )
Abs	17.45 in <sup>2</sup> (112.90 cm <sup>2</sup> )	17.70 in <sup>2</sup> (114.17 cm <sup>2</sup> )	23.39 in <sup>2</sup> (150.89 cm <sup>2</sup> )	31.43 in <sup>2</sup> (205.99 cm <sup>2</sup> )	33.33 in <sup>2</sup> (215.05 cm <sup>2</sup> )	33.35 in <sup>2</sup> (215.13 cm <sup>2</sup> )
Vest	11R	12R	13R	14R	15R	16R
Upper Chest	7.20 in <sup>2</sup> (46.47 cm <sup>2</sup> )	8.14 in <sup>2</sup> (52.49 cm <sup>2</sup> )	9.05 in <sup>2</sup> (58.37 cm <sup>2</sup> )	12.70 in <sup>2</sup> (81.93 cm <sup>2</sup> )	16.83 in <sup>2</sup> (108.59 cm <sup>2</sup> )	16.84 in <sup>2</sup> (108.66 cm <sup>2</sup> )
Lower Chest	5.19 in <sup>2</sup> (33.50 cm <sup>2</sup> )	5.99 in <sup>2</sup> (38.64 cm <sup>2</sup> )	7.60 in <sup>2</sup> (48.97 cm <sup>2</sup> )	8.42 in <sup>2</sup> (54.30 cm <sup>2</sup> )	8.73 in <sup>2</sup> (56.35 cm <sup>2</sup> )	10.48 in <sup>2</sup> (67.59 cm <sup>2</sup> )
Top Upper Back	8.65 in <sup>2</sup> (55.80 cm <sup>2</sup> )	9.62 in <sup>2</sup> (62.04 cm <sup>2</sup> )	10.13 in <sup>2</sup> (65.35 cm <sup>2</sup> )	11.06 in <sup>2</sup> (71.34 cm <sup>2</sup> )	11.98 in <sup>2</sup> (77.29 cm <sup>2</sup> )	11.99 in <sup>2</sup> (77.33 cm <sup>2</sup> )
Bottom Upper Back	7.70 in <sup>2</sup> (49.69 cm <sup>2</sup> )	8.97 in <sup>2</sup> (57.89 cm <sup>2</sup> )	11.47 in <sup>2</sup> (73.99 cm <sup>2</sup> )	13.91 in <sup>2</sup> (89.73 cm <sup>2</sup> )	16.35 in <sup>2</sup> (105.49 cm <sup>2</sup> )	16.42 in <sup>2</sup> (105.94 cm <sup>2</sup> )

Middle Back	6.09 in <sup>2</sup> (39.26 cm <sup>2</sup> )	7.41 in <sup>2</sup> (47.78 cm <sup>2</sup> )	8.95 in <sup>2</sup> (57.74 cm <sup>2</sup> )	10.49 in <sup>2</sup> (67.70 cm <sup>2</sup> )	12.66 in <sup>2</sup> (81.66 cm <sup>2</sup> )	12.66 in <sup>2</sup> (81.70 cm <sup>2</sup> )
Lower Back	10.47 in <sup>2</sup> (67.51 cm <sup>2</sup> )	10.84 in <sup>2</sup> (69.94 cm <sup>2</sup> )	14.62 in <sup>2</sup> (94.34 cm <sup>2</sup> )	19.60 in <sup>2</sup> (126.42 cm <sup>2</sup> )	23.98 in <sup>2</sup> (154.77 cm <sup>2</sup> )	24.00 in <sup>2</sup> (154.83 cm <sup>2</sup> )
Abs	15.27 in <sup>2</sup> (98.52 cm <sup>2</sup> )	15.23 in <sup>2</sup> (98.26 cm <sup>2</sup> )	20.15 in <sup>2</sup> (129.96 cm <sup>2</sup> )	27.53 in <sup>2</sup> (177.60 cm <sup>2</sup> )	28.27 in <sup>2</sup> (182.39 cm <sup>2</sup> )	28.27 in <sup>2</sup> (182.39 cm <sup>2</sup> )
Shorts	11R	12R	13R	14R	15R	16R
Glutes	9.87 in <sup>2</sup> (63.66 cm <sup>2</sup> )	9.32 in <sup>2</sup> (60.12 cm <sup>2</sup> )	14.32 in <sup>2</sup> (92.37 cm <sup>2</sup> )	19.44 in <sup>2</sup> (125.44 cm <sup>2</sup> )	20.88 in <sup>2</sup> (134.69 cm <sup>2</sup> )	27.27 in <sup>2</sup> (134.69 cm <sup>2</sup> )
Hamstrings	13.43 in <sup>2</sup> (86.62 cm <sup>2</sup> )	16.26 in <sup>2</sup> (104.88 cm <sup>2</sup> )	18.85 in <sup>2</sup> (121.60 cm <sup>2</sup> )	24.03 in <sup>2</sup> (155.05 cm <sup>2</sup> )	27.27 in <sup>2</sup> (175.95 cm <sup>2</sup> )	27.27 in <sup>2</sup> (175.95 cm <sup>2</sup> )
Quads	13.43 in <sup>2</sup> (86.62 cm <sup>2</sup> )	16.26 in <sup>2</sup> (104.88 cm <sup>2</sup> )	18.85 in <sup>2</sup> (121.60 cm <sup>2</sup> )	24.03 in <sup>2</sup> (155.05 cm <sup>2</sup> )	27.27 in <sup>2</sup> (175.95 cm <sup>2</sup> )	27.27 in <sup>2</sup> (175.95 cm <sup>2</sup> )
Arm Straps	11R	12R	13R	14R	15R	16R
Arms	7.17 in <sup>2</sup> (46.24 cm <sup>2</sup> )	9.15 in <sup>2</sup> (59.03 cm <sup>2</sup> )	11.13 in <sup>2</sup> (71.82 cm <sup>2</sup> )	13.75 in <sup>2</sup> (88.68 cm <sup>2</sup> )	16.30 in <sup>2</sup> (105.18 cm <sup>2</sup> )	16.30 in <sup>2</sup> (105.18 cm <sup>2</sup> )

Specifications for Gen2/Gen3: 1064-01-XXX, 1065-01-XXX, 1066-01-XXX

Muscle Group Electrode	Surface area by square inch (square cm)					
Vest	XS	S	M	L	XL	XXL
Upper Chest	4.31 in <sup>2</sup> (27.79 cm <sup>2</sup> )	4.31 in <sup>2</sup> (27.79 cm <sup>2</sup> )	6.96 in <sup>2</sup> (44.89 cm <sup>2</sup> )	8.34 in <sup>2</sup> (53.79 cm <sup>2</sup> )	10.23 in <sup>2</sup> (65.99 cm <sup>2</sup> )	10.23 in <sup>2</sup> (66.00 cm <sup>2</sup> )
Lower Chest	5.39 in <sup>2</sup> (34.76 cm <sup>2</sup> )	5.39 in <sup>2</sup> (34.76 cm <sup>2</sup> )	7.51 in <sup>2</sup> (48.46 cm <sup>2</sup> )	12.69 in <sup>2</sup> (81.86 cm <sup>2</sup> )	12.69 in <sup>2</sup> (81.86 cm <sup>2</sup> )	12.48 in <sup>2</sup> (80.50 cm <sup>2</sup> )
Upper Back	4.30 in <sup>2</sup> (27.71 cm <sup>2</sup> )	5.70 in <sup>2</sup> (36.81 cm <sup>2</sup> )	8.70 in <sup>2</sup> (56.11 cm <sup>2</sup> )	10.42 in <sup>2</sup> (67.21 cm <sup>2</sup> )	11.36 in <sup>2</sup> (73.31 cm <sup>2</sup> )	11.16 in <sup>2</sup> (72.00 cm <sup>2</sup> )
Middle Back	5.82 in <sup>2</sup> (37.58 cm <sup>2</sup> )	7.37 in <sup>2</sup> (47.58 cm <sup>2</sup> )	8.92 in <sup>2</sup> (57.58 cm <sup>2</sup> )	10.47 in <sup>2</sup> (67.58 cm <sup>2</sup> )	12.02 in <sup>2</sup> (77.58 cm <sup>2</sup> )	12.4 in <sup>2</sup> (80.00 cm <sup>2</sup> )

Lower Back	9.96 in <sup>2</sup> (64.24 cm <sup>2</sup> )	9.96 in <sup>2</sup> (64.24 cm <sup>2</sup> )	15.09 in <sup>2</sup> (97.34 cm <sup>2</sup> )	20.33 in <sup>2</sup> (131.14 cm <sup>2</sup> )	20.33 in <sup>2</sup> (131.14 cm <sup>2</sup> )	21.16 in <sup>2</sup> (136.50 cm <sup>2</sup> )
Abs	16.61 in <sup>2</sup> (107.14 cm <sup>2</sup> )	16.61 in <sup>2</sup> (107.14 cm <sup>2</sup> )	24.42 in <sup>2</sup> (157.54 cm <sup>2</sup> )	33.07 in <sup>2</sup> (213.34 cm <sup>2</sup> )	33.07 in <sup>2</sup> (213.34 cm <sup>2</sup> )	37.78 in <sup>2</sup> (243.75 cm <sup>2</sup> )
Shorts	XS	S	M	L	XL	XXL
Glutes	9.96 in <sup>2</sup> (64.24 cm <sup>2</sup> )	9.96 in <sup>2</sup> (64.24 cm <sup>2</sup> )	15.09 in <sup>2</sup> (97.34 cm <sup>2</sup> )	20.33 in <sup>2</sup> (131.14 cm <sup>2</sup> )	20.33 in <sup>2</sup> (131.14 cm <sup>2</sup> )	20.34 in <sup>2</sup> (131.25 cm <sup>2</sup> )
Hamstrings	13.09 in <sup>2</sup> (84.44 cm <sup>2</sup> )	17.09 in <sup>2</sup> (110.24 cm <sup>2</sup> )	19.75 in <sup>2</sup> (127.44 cm <sup>2</sup> )	25.09 in <sup>2</sup> (161.84 cm <sup>2</sup> )	27.75 in <sup>2</sup> (179.04 cm <sup>2</sup> )	28.99 in <sup>2</sup> (187.05 cm <sup>2</sup> )
Quads	13.09 in <sup>2</sup> (84.44 cm <sup>2</sup> )	17.09 in <sup>2</sup> (110.24 cm <sup>2</sup> )	19.75 in <sup>2</sup> (127.44 cm <sup>2</sup> )	25.09 in <sup>2</sup> (161.84 cm <sup>2</sup> )	27.75 in <sup>2</sup> (179.04 cm <sup>2</sup> )	28.99 in <sup>2</sup> (187.05 cm <sup>2</sup> )
Arm Straps	XS	S	M	L	XL	XXL
Arms	6.68 in <sup>2</sup> (44.38 cm <sup>2</sup> )	8.23 in <sup>2</sup> (53.12 cm <sup>2</sup> )	10.26 in <sup>2</sup> (66.22 cm <sup>2</sup> )	12.30 in <sup>2</sup> (79.40 cm <sup>2</sup> )	15.00 in <sup>2</sup> (96.80 cm <sup>2</sup> )	21.08 in <sup>2</sup> (136.00 cm <sup>2</sup> )

### Battery

Lithium Polymer (LiPo) rechargeable 7.4V, 2050 mAh

### Charging Input

5V through Micro USB Connector

### Stimulation Channels

13 Channels

### Stimulation Waveform

Bipolar Symmetrical

### Supported Stimulation Frequency Range

1 to 105 Hz

**Supported Stimulation Pulse Widths**

250 to 375 microseconds

**Maximum Output Voltage**

100 Volts

**Maximum Output Current**

120 milli-Amps

**Wireless Connection**

Built-in BLE Module

**Electromagnetic Compatibility**

IEC 60601-1-2

**Frequency band**

2.360 GHz to 2.500 GHz GHz

**Max radio frequency power**

+4 dBm

**Housing materials**

Plastic injection molding

**Environment Specifications**

- Operating/Storage/Transport: Temperature from 32° F to 104° F (0° C to +40° C)

- Humidity: 10-90% RH
- Atmospheric pressure: from 700 hPa to 1060 hPa (10.15 to 15.37 psi)

### Limitations

The product is not suitable for use in environments with a high concentration of oxygen and/or flammable liquids and/or flammable gas; do not use with equipment for electrosurgery or shortwave or microwave therapy; the device may be interfered with by other equipment, even if that other equipment complies with CISPR EMISSION requirements.

### Emissions

Standard	Item	Remarks
IEC 60601-2-10	Conducted Emissions	Class B
	Radiated Emissions	Class B
	Harmonic Emissions	
	Voltage Fluctuation and Flicker Emissions	

### Immunity

Standard	Item	IEC 60601-1-2 Test Levels	Remarks
IEC 60601-1-2	Electrostatic Discharge	Contact: $\pm 8\text{kV}$ Air: $\pm 2\text{kV}$ , $\pm 4\text{kV}$ , $\pm 8\text{kV}$ , and $\pm 15\text{kV}$	No performance degradation observed.
	Radiated Immunity	80MHz to 2.7GHz, 10V/m; @ 80%, 1kHz and Table 9 of Clause 8.10	No performance degradation observed.
	Electrical Fast Transients/Bursts	AC Mains: 2kV, 100kHz PRF DC Mains: NA	No performance degradation observed.

	Surge	AC Mains: $\pm 0,5$ kV and $\pm 1$ kV Line to Line, $\pm 0,5$ kV, $\pm 1$ kV and $\pm 2$ kV Line to Ground  DC Mains: NA  IO Lines: NA	No performance degradation observed.
	Conducted Immunity	AC Mains: 150kHz to 80MHz, 3 Vrms outside ISM and amateur radio bands, 6 Vrms in ISM and amateur radio bands: @ 80%, 1kHz  IO Lines: 150kHz to 80MHz, 3 Vrms outside ISM and amateur radio bands, 6 Vrms in ISM and amateur radio bands: @ 80%, 1kHz DC Mains: NA	No performance degradation observed.
	Magnetic Immunity	30A/m, 50Hz and 60Hz	No performance degradation observed.
	Voltage Dips and Interrupts	0% for 0.5 cycle (at 0°, 45°, 90°, 135°, 180°, 225°, 270° and 315°), 0% for 1 cycle (at 0°), 70% for 25 cycles (at 0°), and 0% for 250 cycles. (Tested at 230VAC and 100VAC)	No performance degradation observed.

## FCC Requirements

The Katalyst Training System has been tested and found to comply with the limits for a Class B digital device, pursuant to part 15 of the FCC Rules. These limits are designed to provide reasonable protection against harmful interference in a residential environment.



The Katalyst Training System is intended to be operated in environments with other RF-capable devices and as such, will comply with the following two conditions:

- The Katalyst Training System may not cause harmful interference.

- The Katalyst Training System must accept any interference received, including the interference that may cause undesired operation.



Contains RF module with FCC ID: 2AA9B10



## SYMBOLS GLOSSARY



Symbol	Symbol Title	Description	Standard Reference		
			Symbol Reference #	Designation #	Standard Title
	Caution	Indicates the need for the user to consult the instructions for use for important cautionary information such as warnings and precautions that cannot, for a variety of reasons, be presented on the medical device itself.	5.4.4	ISO 15223-1:2016	Medical devices – Symbols to be used with medical device labels, labeling and information to be supplied – Part 1: General requirements
	Refer to instruction manual/booklet	Indicates the instruction manual must be read.	M002	ISO 7010	Graphics symbols – Safety colors and safety signs – Registered safety signs
	Manufacturer	Indicates the medical device manufacturer, as defined in Directives 90/385/ECC,	5.1.1	ISO 15223-1:2016	Medical devices – Symbols to be used with medical device labels,







		93/42/EDD and 98/79/EC			labeling and information to be supplied – Part 1: General requirements
	Date of Manufacture	Indicates the date when the medical device was manufactured.	5.1.3	ISO 15223-1:2016	Medical devices – Symbols to be used with medical device labels, labeling and information to be supplied – Part 1: General requirements
<b>REF</b>	Catalog number	Indicates the manufacturer’s catalog number so that the medical device can be identified.	5.1.6	ISO 15223-1:2016	Medical devices – Symbols to be used with medical device labels, labeling and information to be supplied – Part 1: General

					requirements
	Serial Number	Indicates the manufacturer's serial number so that a specific medical device can be identified.	5.1.7	ISO 15223-1:2016	Medical devices – Symbols to be used with medical device labels, labeling and information to be supplied – Part 1: General requirements
	Lot number	Indicates the manufacturer's lot number so that the lot number can be identified.	5.1.5	ISO 15223-1:2016	Medical devices – Symbols to be used with medical device labels, labeling and information to be supplied – Part 1: General requirements
	Type BF Applied Part	Indicates a type BF applied part complying with ICE 60601-1 BF=Body	5333	IEC 60417:2002	Graphical Symbols for Use on Equipment

		Floating. Used for devices which have conductive contact with patient or having medium- or long-term contact with patient. May not be connected to earth (floating).			
	Temperature limit	Indicates the temperature limits to which the medical device can be safely exposed.	5.3.7	ISO 15223-1:2016	Medical devices – Symbols to be used with medical device labels, labeling and information to be supplied – Part 1: General requirements
	Humidity limitation	Indicates the range of humidity to which the medical device can be safely exposed.	5.3.8	ISO 15223-1:2016	Medical devices – Symbols to be used with medical device labels, labeling and information to be supplied –

					Part 1: General requirements
	WEEE	Waste in Electrical and Electronic Equipment. Indicates a product should not be disposed of in a landfill; the black bar indicates that the equipment was manufactured after 2005.	-	EN 50419:2006	Marking of electrical and electronic equipment in accordance with article 11(2) of directive 2002/96/EC (WEEE)
	Stand-by	Indicates a sleep mode or low power state. The switch does not fully disconnect the device from its power supply.	5009	IEC 60417:2002	Graphical Symbols for Use on Equipment
	FCC Marking	FCC marking indicates the electronic device, which sold in the United States, is certified and the electromagnetic interference from the device	-	Federal Communications	-

		is under the limits that are approved by Federal Communications Commission.			
	CE Mark	CE marking indicates certification that a product meets the European Union's (EU) health, safety, performance, and environmental requirements	-	The European Union (EU)	-
	Do not use if package is damaged	Indicates the device should not be used if the package has been damaged or opened.	5.2.8	ISO 15223-1:2016	Medical devices – Symbols to be used with medical device labels, labeling and information to be supplied – Part 1: General requirements
	Do not dry-clean	Indicates the garment cannot be safely dry-cleaned	-	ISO 3758:2012	Textiles – Care labeling code using symbols

		without damage.			
	Do not iron	Indicates the garment cannot be safely ironed without damage.	-	ISO 3758:2012	Textiles – Care labeling code using symbols
	Do not tumble dry	Indicates the garment cannot be safely tumble-dried without damage.	-	ISO 3758:2012	Textiles – Care labeling code using symbols
	Do not bleach	Indicates the garment cannot be safely bleached without damage.	-	ISO 3758:2012	Textiles – Care labeling code using symbols
	Wash in cold water with mild washing conditions	Indicates the garment can be safely washed in very mild washing with a maximum temperature of 30°C (86°F).	-	ISO 3088:2011	Textiles – Care labeling code using symbols

## **ELECTROMAGNETIC COMPATIBILITY (EMC)**

The Katalyst Training System is designed for use in typical domestic approved environments in accordance with the safety standard IEC 60601-1-2.

The Katalyst Training System is designed to support the anticipated disturbance originating from electrostatic discharge, magnetic fields for the power supply, or radiofrequency emitters. However, the Katalyst Training System may be affected by powerful radiofrequency fields that come from other sources.

If loss or degradation of essential performance occurs, safety and effectiveness can be compromised, and termination of the training is advised.

## **PRODUCT SUPPORT**

Please email the manufacturer at [support@katalyst.com](mailto:support@katalyst.com) for additional information on setup, use, and maintenance or to report any issues with your Katalyst Training System.

# KATALYST

## EU Declaration of Conformity (No. 1000)

In accordance with European Parliament and Council Decision No 768/2008/EC Annex III

1. *Product model / product:*

Product Katalyst Training System (Muscle Stimulation Device)

Model/type Model 1

Batch/serial no. Impulse Packs: SIXXxxxx

Suits: KVAAXXXX, KSAAXXXX, KAAAXXXX, Lot # - M00-XXXX

2. *Manufacturer:*

Name Katalyst Interactive Inc.

Address 8400 W Sunset Road, Suite 300, Las Vegas, Nevada, 89113, United States

*Authorised Representative.*<sup>5</sup>

Name Authorised Representative Service

Address 77 Camden Street Lower

Dublin

D02 XE80

Ireland



3. *This declaration is issued under the sole responsibility of the manufacturer.*

4. *Object of the declaration:*

Product Katalyst Training System (Muscle Stimulation Device)

Specification: The Katalyst Training System is a battery powered muscle stimulator that uses electrical muscle stimulation (EMS) technology to stimulate your muscles and help to improve muscle performance. Specifically, it uses neuromuscular electrical stimulation (NMES) to stimulate motor nerves, creating a muscle contraction to recruit more muscle fibers while training. It is designed to be used with the Katalyst Application, which is the interface between the user and the Impulse Pack and runs on a user supplied iOS device. The iOS device communicates wirelessly with the Impulse Pack using Bluetooth 4.2.



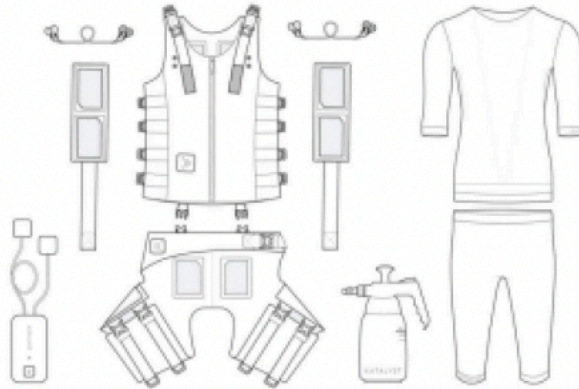

5. *The object of the declaration described above is in conformity with the relevant Union harmonisation legislation:*

2014/53/EU The Radio Equipment Directive

2011/65/EU The Restriction of Hazardous Substances Directive

6. *References to the relevant harmonised standards used or references to the other technical specifications in relation to which conformity is declared:*

**Reference & Date Title**

**Article 3.1(a) – Electrical Safety**

*EN 60601-2-10: 2015 + A1: 2016 Medical Electrical equipment – Particular requirements for the basic safety and essential performance of nerve and muscle stimulators*

*EN 62479: 2010 Assessment of the compliance of low power electronic and electrical equipment with the basic restrictions related to human exposure to electromagnetic fields*

*EN 60601-1 Medical electrical equipment – Part 1: General requirements for basic safety and essential performance*

**Article 3.1(b) – Electromagnetic Compatibility**

*EN 301 489-1 V2.2.3 Part 1: Common technical requirements; Harmonised Standard covering the essential requirements of article 3.1(b) of Directive 2014/53/EU and the essential requirements of article 6 of Directive 2014/30/EU*

*EN 301 489-17 V3.2.4 ElectroMagnetic Compatibility (EMC) standard for radio equipment and services; Part 17: Specific conditions for Broadband Data Transmission Systems; Harmonised Standard covering the essential requirements of article 3.1(b) of Directive 2014/53/EU*

**Article 3.2 – Spectrum efficiency**

*EN 300 328 V2.2.2 Wideband transmission systems; Data transmission equipment operating in the 2.4 GHz band; Harmonised Standard for access to the radio spectrum*

**Article 3.3 – Other requirements**

**7. Additional information:**

This product is not a medical device.

Signed for and on behalf of: Katalyst Interactive Inc. Place  
of issue: Las Vegas, Nevada, USA

Date of issue:

Name: Linda K. Alcorn

Function: Manager, Quality

Systems Signature:

Signed by:  
  
FA2773FC53804A6...